

MODELS

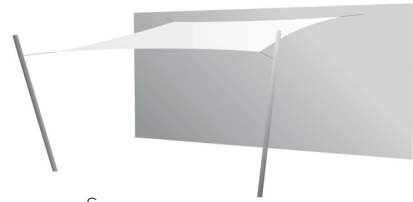

Triangle



Square



Rectangle

POSITIONS

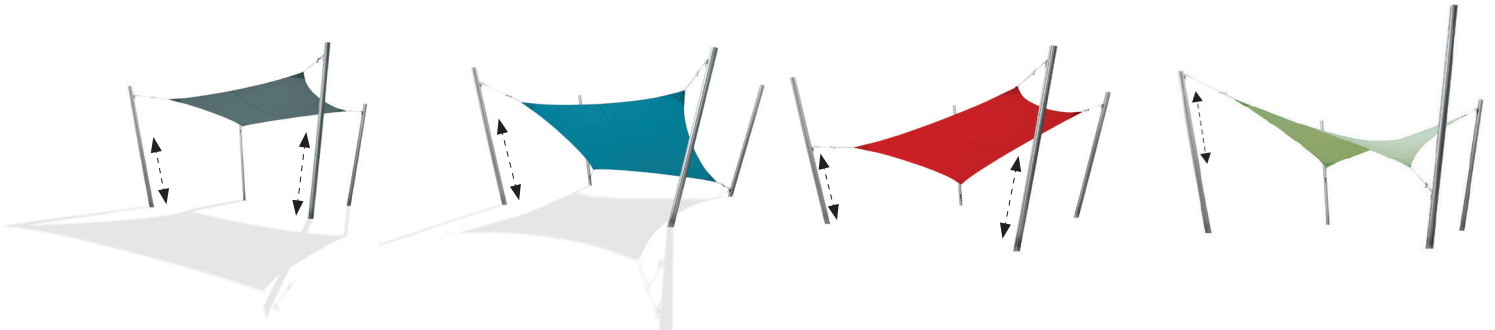

COLORS



DIMENSIONS

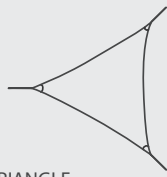

TRIANGLE

- 4x4x4m/13' 1"x13' 1"x13' 1"
- 5x5x5m/16' 5"x16' 5"x16' 5"

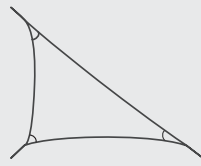

RIGHT-ANGLED TRIANGLE

- 4x5x6.4m/13' 1"x16' 5"x21'

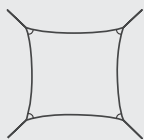
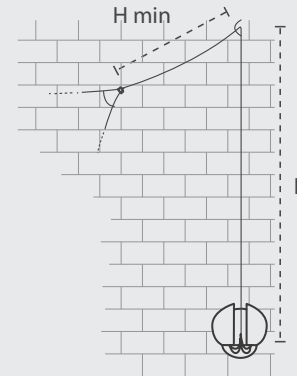
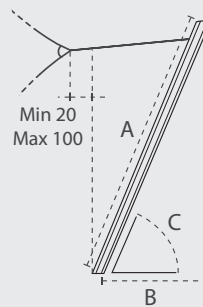

SQUARE

- 3x3m/9' 10"x9' 10"
- 4x4m/13' 1"x13' 1"

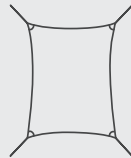

RECTANGLE

- 3x4m/9' 10"x13' 1"
- 3x5m/9' 10"x16' 5"

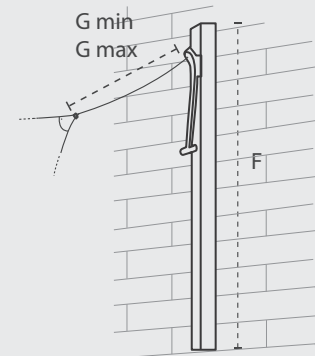
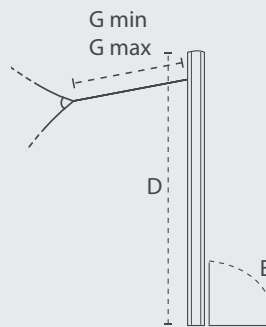

	A cm/ft	B cm/ft	C	D cm/ft	E	F cm/ft	G min cm/ft	G max cm/ft	H cm/inch	H+I cm/ft
INGENUA +/- 2% +-----+ -----	260/8' 7" 300/9' 10"	65/2' 1.6" 75/2' 5.5"	80°	260/8' 7"	90°	165/5' 5"	50/1' 8"	150/4' 11"	20/8"	<500/<16' 5"

MATERIALS

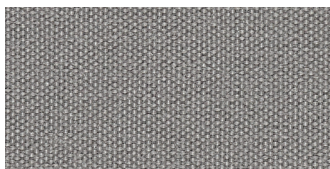

FABRIC

- Solidum – 100% Acryl 255 gr/m²
- Sunbrella – 100% Acryl 260 gr/m²
- More details – see spec sheet Fabrics



POLE

- Naturally anodized aluminum
- White – RAL 9016 TEC
- Black – RAL 9005 TD



OTHER MATERIALS

- Carabiner: stainless steel 316 (marine grade)
- Handle: stainless steel 316 (casted & polished)
- Rope: Ø 6mm/0,24"

For projects – consult Umbrosa for powder coating finish options (RAL).

PACKAGING & TRANSPORT

Ingenua	L (cm)	W (cm)	H (cm)	Weight (kg)	L (")	W (")	H (")	Weight (lbs)
Box pole	270	10	8,5	7,3	8'10"	4"	3"	16
Bag Sail	45	55	16	2,23 - 5,26	1'5"	1'10"	6"	5-11

NICE TO KNOW

- Spare parts available
- Designed and manufactured in Belgium
- Warranty between 15 and 2 years, see Warranty Sheet
- Manual included
- Storage bag included (PU coated fabric)
- Wind speeds up to 6 beaufort, 50 km/h, 31 mph when base is permanently fixed
- Tested at TU Delft